

CL-202(S)

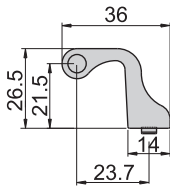

材 質	鐵
表面處理	後鈕座---(S)噴砂、鍍鉻
	後鈕管---材料本質
	心軸---電鍍

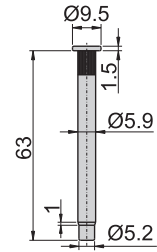
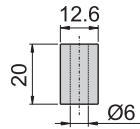
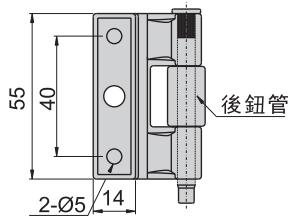
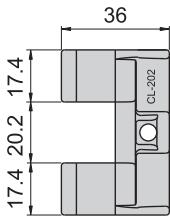

鉸  
鏈

丁 雙

75#

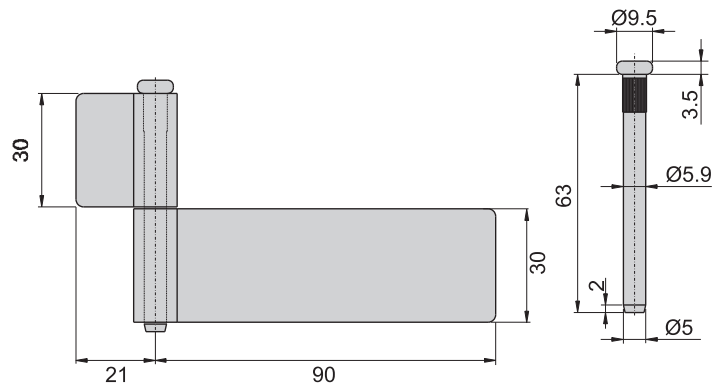
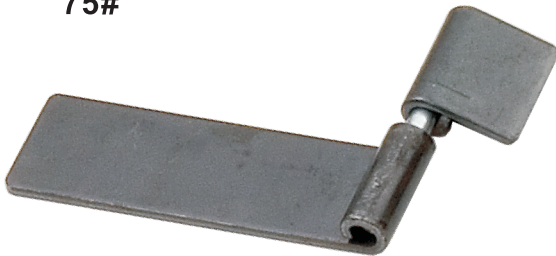

材 質	鐵
表面處理	葉子---材料本質
	心軸---電鍍

