

CPA-406-18-1-H(六角)

CPA-406-18-2-H(圓)

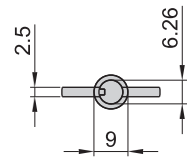

CPA-406-18-1-PH

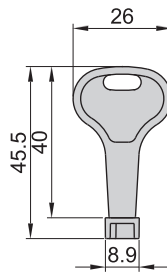
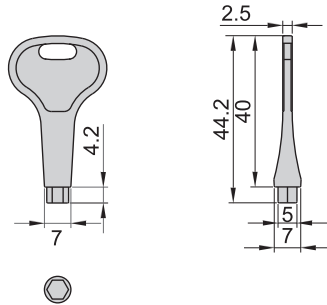
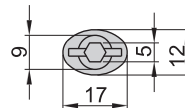
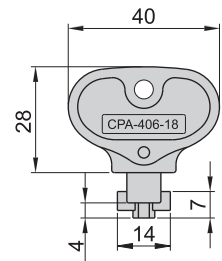
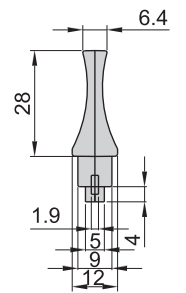
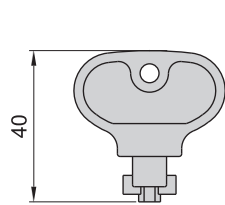

NL-406-Ø32

